



SWITCH TYPE	Micro Switches	MODEL NO.	VM5-02N-**-U10
-------------	----------------	-----------	----------------

1. Functional spec.

1.1 Rated Voltage	125/250VAC	1.6 Free Position	19.95 ± 0.8mm
1.2 Rated Current	5A	1.7 Operating Position	18.25 ± 0.8mm
1.3 Contact Resistance	≤ 100mΩ (Initial value)	1.8 Position Travel	
1.4 Operating Force	(**) gf	1.9 Return Force	
1.5 Bounce Time		1.10	

2. Reliable Rating

2.1 Mechanical Life	100,000 CYCLES	2.5 Soldering Technic	Hand Soldering
2.2 Electrical Life	10,000 CYCLES	2.6 Operating Temper	-25° C - +85° C
2.3 Insulation Resistance	≥ 100MΩ DC500V (Initial value)	2.7 Ambient Humidity Used	< 85%RH
2.4 Withstand Voltage	AC1500V 1 minute (Initial value)	2.8	

3. Dimension Drawing

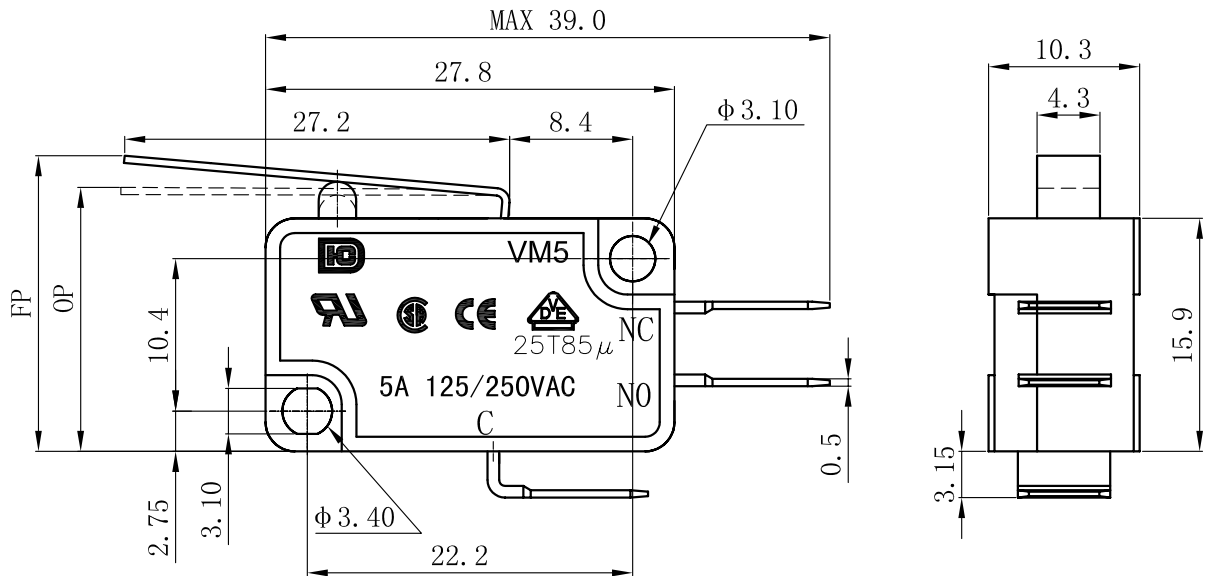

SCHEMATIC

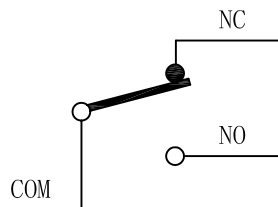

Revision	Description	Date	Revisor
Drawing No.	C/0	Tolerance	± 0.2
Drawing Model.	SPECIFICATION OF STANDARD TYPE	Unit	mm
Prepared	Reviewed	Approved	Effective date